

WATER TANKS

Available in 15 Litre to 60 Litre and feature a Soap or Sunscreen Dispenser.

364 WATER TANKS - WATER TANKS



WATER TANK TRUCK, TRAILER & UTE
15 LITRE SQUARE - INCL. SOAP DISPENSER



15L / 23L
WATER TANKS

MATERIAL
Polyethylene

FINISH
Black

DESCRIPTION

Water Tank and Dispenser.
(Replacement Dispensers available)



15L



23L

SPECIFICATIONS FOR 15L

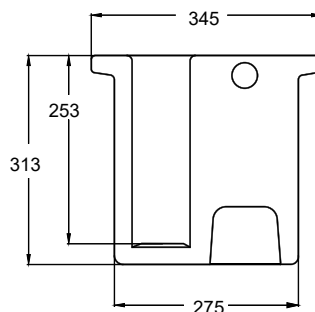

Front

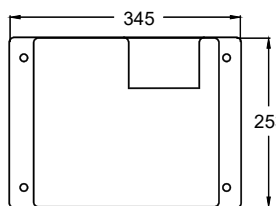

Bottom

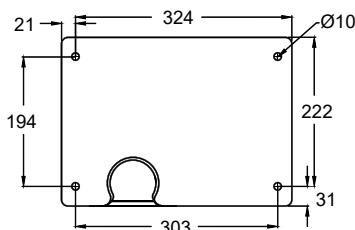

Top

SPECIFICATIONS FOR 23L

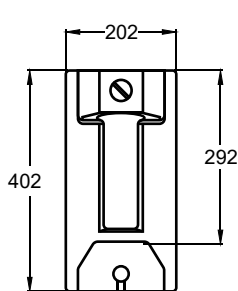

Front

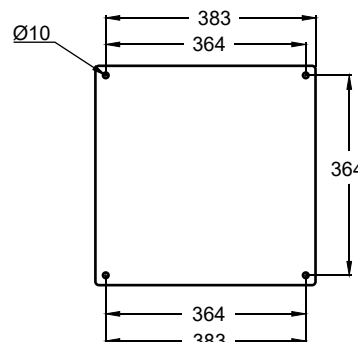

Side

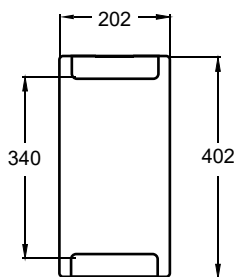

Back

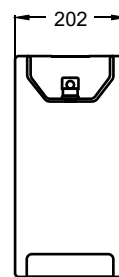

Bottom

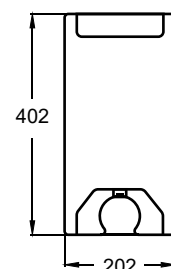

Top

McNaughtans
Administration & Melbourne Branch

321 Greens Rd, Keysborough, VIC 3173
Mon - Fri : 8 AM - 4:30 PM
03 8768 6666
vicsales@mcnaughtans.com.au

McNaughtans
Brisbane

925 Nudgee Road, Banyo, Qld 4014
Mon - Fri : 8 AM - 4:30 PM
07 32677722
qldsales@mcnaughtans.com.au

McNaughtans
Sydney

2/314 Hoxton Park Road, Prestons, NSW 2170
Mon - Fri : 8 AM - 4:30 PM
02 9609 5122
nsw@mcnaughtans.com.au

McNaughtans
Perth

3 Kalli Street, Malaga, WA 6090
Mon - Fri : 8 AM - 4:30 PM
08 9248 1833
wainfo@mcnaughtans.com.au

Struts Australia
Laverton

3/110 Fitzgerald Road, Laverton North, VIC 3026
Mon - Fri : 8 AM - 4:30 PM
03 9369 8113
info@strutsaustralia.com

Concept Latch, Lock and Hinge
Brunswick

353 Victoria Street, Brunswick, VIC 3056
Mon - Thurs 9 AM - 5 PM, Fri 9 AM - 4 PM
03 9388 2551
sales@conceptlatch.com.au

30L / 60L
WATER TANKS

MATERIAL
Polyethylene

FINISH
Black

DESCRIPTION

Water Tank and Dispenser.
(Replacement Dispensers available)



30L

SPECIFICATIONS

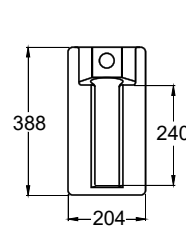

Front

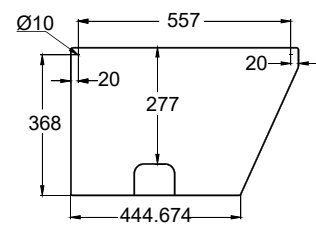

Side

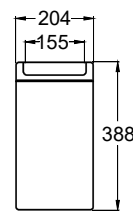

Back

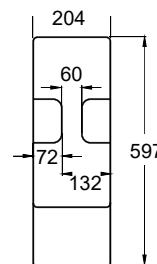

Bottom

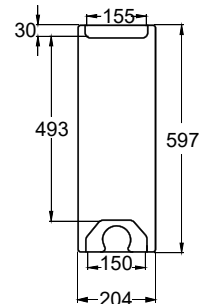

Top



60L

SPECIFICATIONS

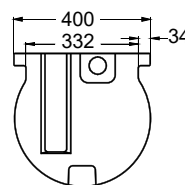

Front

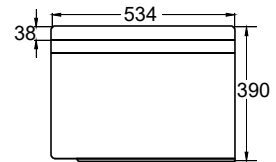

Side

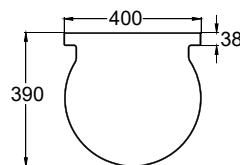

Back

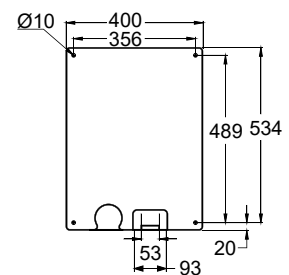

Top

WT18-IDRO / WT25-IDRO / WT40-IDRO
WATER TANKS

MATERIAL
Polyethylene

FINISH
Black

DESCRIPTION
 Water Tank and Dispenser.



WT18-IDRO

SPECIFICATIONS

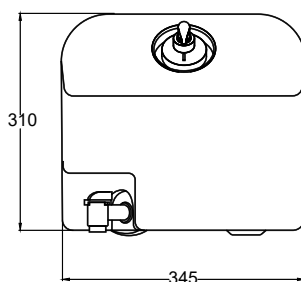

Front

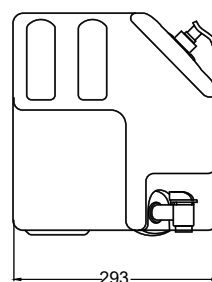

Side



WT25-IDRO

SPECIFICATIONS

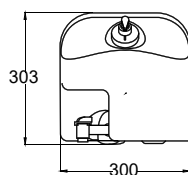

Front

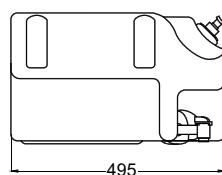

Side

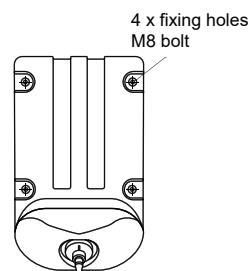

Bottom



WT40-IDRO

SPECIFICATIONS

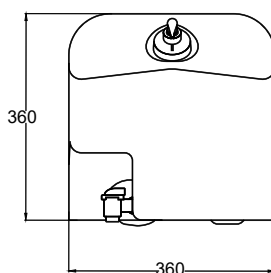

Front

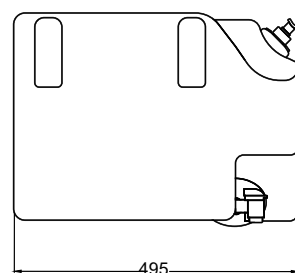

Side

McNaughtans
Administration & Melbourne Branch

321 Greens Rd, Keysborough, VIC 3173
 Mon - Fri : 8 AM - 4:30 PM
 03 8768 6666
 vic-sales@mcnaughtans.com.au

McNaughtans
Brisbane

925 Nudgee Road, Banyo, Qld 4014
 Mon - Fri : 8 AM - 4:30 PM
 07 32677722
 qld-sales@mcnaughtans.com.au

McNaughtans
Sydney

2/314 Hoxton Park Road, Prestons, NSW 2170
 Mon - Fri : 8 AM - 4:30 PM
 02 9609 5122
 nsw@mcnaughtans.com.au

McNaughtans
Perth

3 Kalli Street, Malaga, WA 6090
 Mon - Fri : 8 AM - 4:30 PM
 08 9248 1833
 wa-info@mcnaughtans.com.au

Struts Australia
Laverton

3/110 Fitzgerald Road, Laverton North, VIC 3026
 Mon - Fri : 8 AM - 4:30 PM
 03 9369 8113
 info@strutsaustralia.com

Concept Latch, Lock and Hinge
Brunswick

353 Victoria Street, Brunswick, VIC 3056
 Mon - Thurs 9 AM - 5 PM, Fri 9 AM - 4 PM
 03 9388 2551
 sales@conceptlatch.com.au

WT32 / WT50
WATER TANKS

MATERIAL
Polyethylene

FINISH
Black

DESCRIPTION

Water Tank and Dispenser.

SPECIFICATIONS



WT32

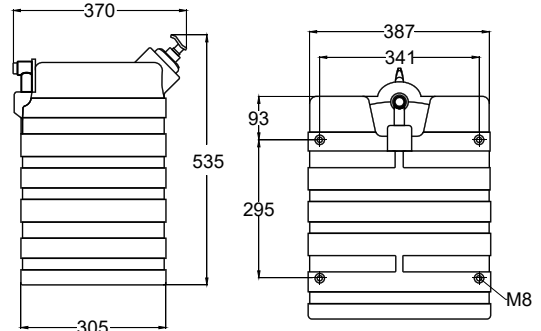

Side

Bottom

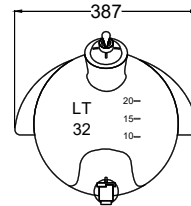

Front

SPECIFICATIONS



WT50

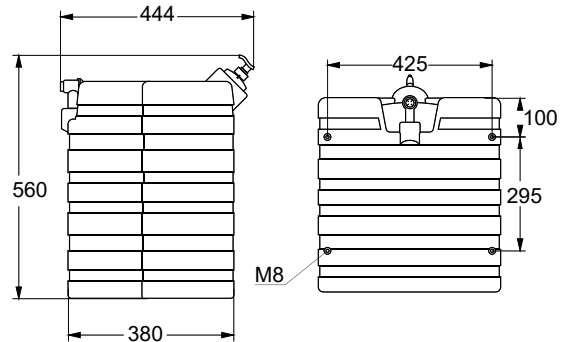

Side

Bottom

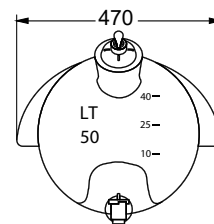

Front